

ペーパークラフトのつくりかたは、Hondaサイト内検索で「アシモペーパークラフト」と入力して検索。
 【ASIMOペーパークラフト】 <http://www.honda.co.jp/ASIMO/fan/papercraft/>

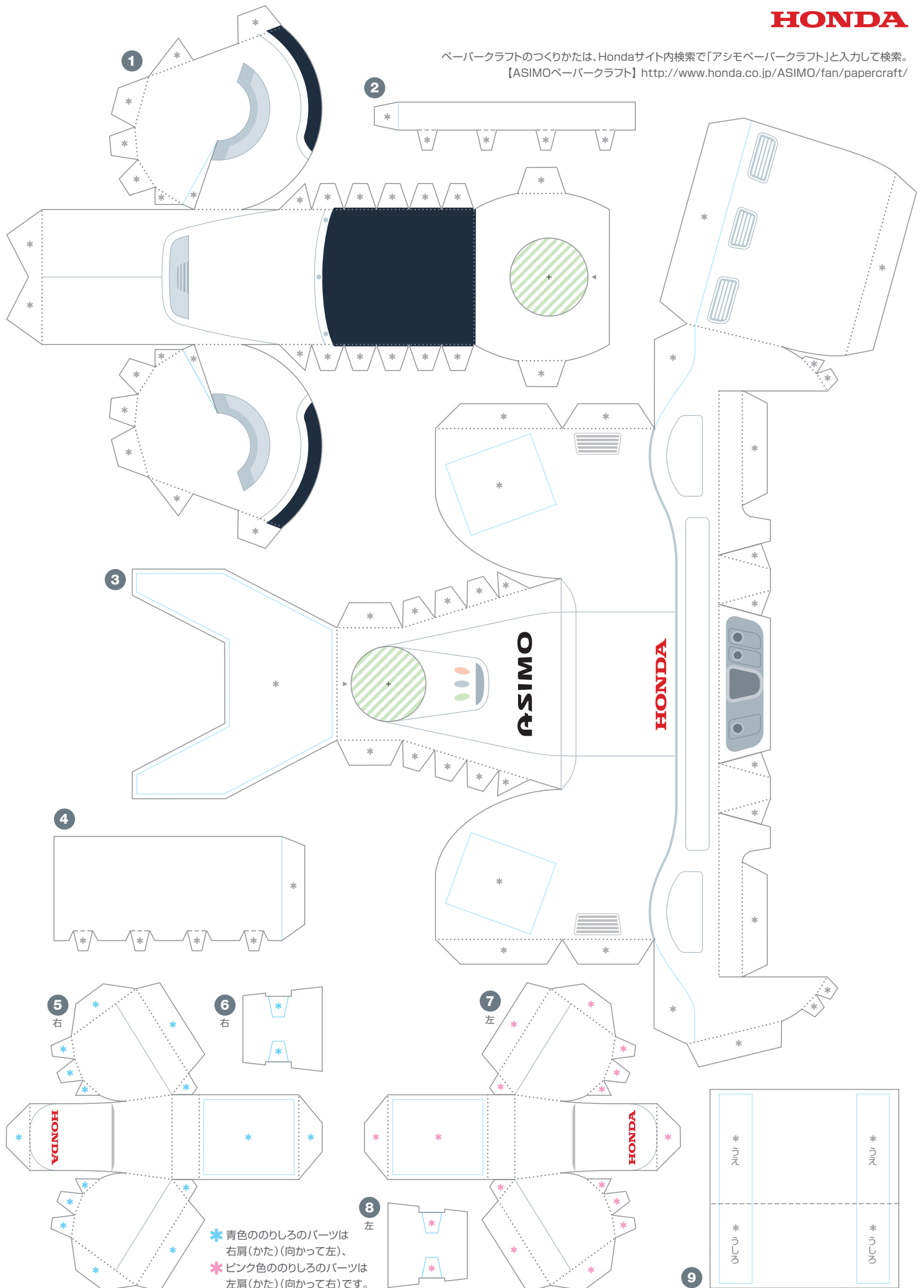

* 青色ののりしろのパーツは
 右肩(かた)(向かって左)、
 * ピンク色ののりしろのパーツは
 左肩(かた)(向かって右)です。

9

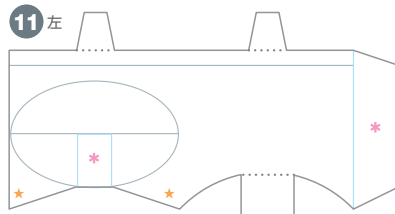
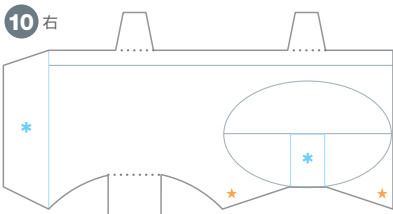

わすれずに
切り込みを
いれる

わすれずに
切り込みを
いれる

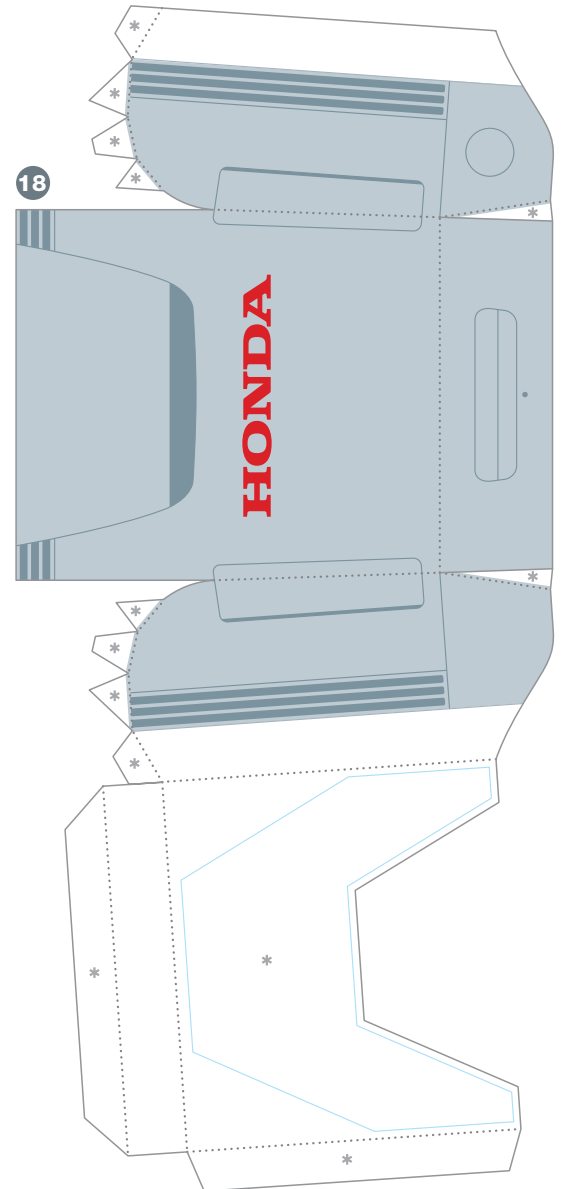
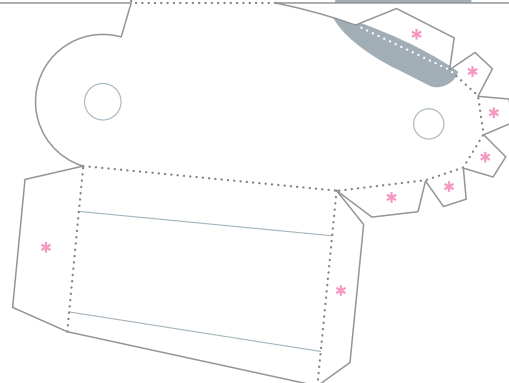
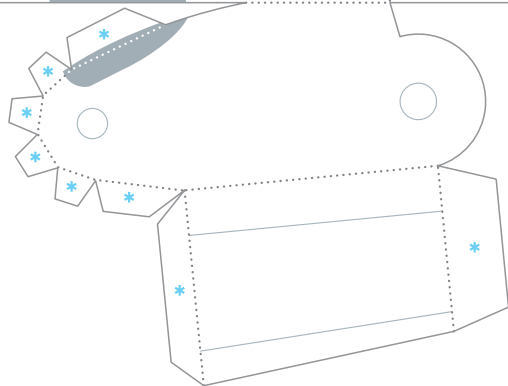
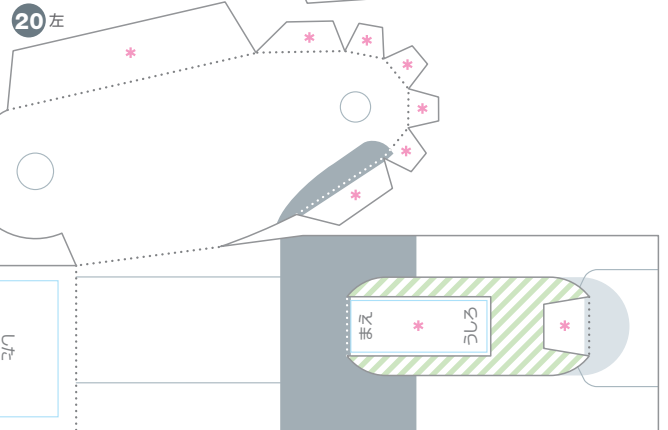
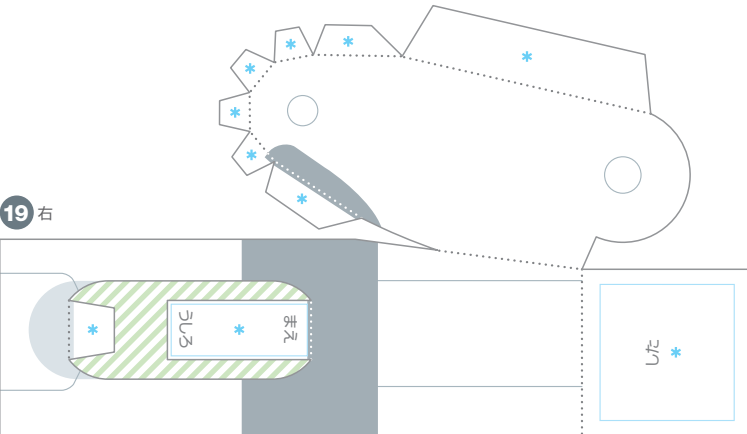
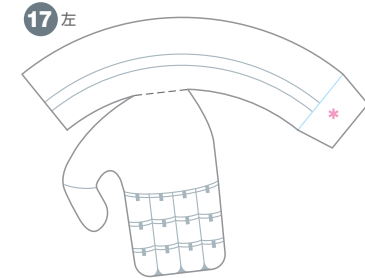
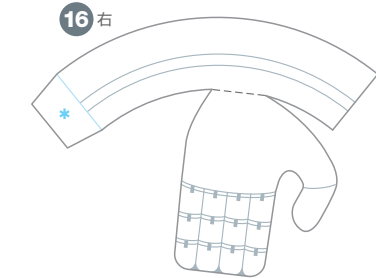
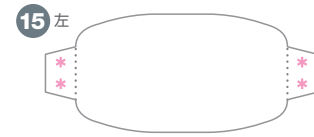
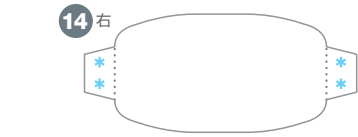
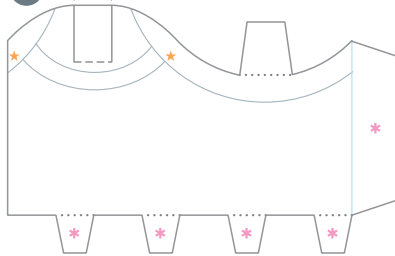
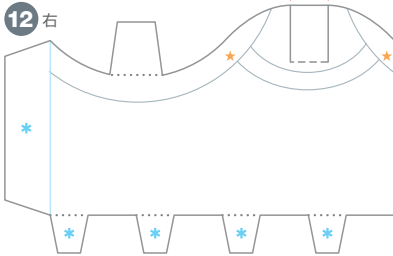

- * 青色ののりしろのパーツは右うでと右足(向かって左)、
- * ピンク色ののりしろのパーツは左うでと左足(向かって右)です。

* 青色ののりしろの
 パーツは右足(向かって左)、
 * ピンク色ののりしろの
 パーツは左足(向かって右)です。

